



SPECIFICATION SHEET

SPECIFICATION SHEET NO.	P0610- SOT23BT5551SG1
DATE	June 10, 2022
REVISION	A0
DESCRIPTION	SMD Plastic-Encapsulate Transistors, SOT-23 series, 3 pads MMBT5551 Type, NPN, Collector-Emitter Voltage 160V. Collector Current 600mA Max. Operating Temp. Range -55°C ~+150°C, Package in Tape/Reel, 3000pcs/Reel RoHS/RoHS III compliant
CUSTOMER	
CUSTOMER PART NUMBER	
CROSS REF. PART NUMBER	
ORIGINAL PART NUMBER	MDD MMBT5551
PART CODE	SOT23BT5551SG1

VENDOR APPROVE			
Issued/Checked/Approved			
DATE: June 10, 2022			

CUSTOMER APPROVE	
DATE:	

6/13/2022

SMD PLASTIC-ENCAPULATE TRANSISTORS SOT23 SERIES

MAIN FEATURE

- Complementary to MMBT5401
- Ideal for Medium Power Amplification and Switching



APPLICATION

- Ideal for Medium Power Amplification and Switching

RFQ

[Request For Quotation](#)

PART CODE GUIDE

SOT23	BT5551	S	G1
1	2	3	4

1) **SOT23**: SMD Plastic-Encapsulate Transistors, 3 pads SOT-23 series Code

2) **BT5551**: Type code for MMBT5551

3) **S**: Package code, Package in Tape/Reel, 3000pcs/Reel

4) **G1**: Marking code for "G1" on the case surface, Different Marking for different specification.

SMD PLASTIC-ENCAPULATE TRANSISTORS SOT23 SERIES

DIMENSION (Unit: Inch/mm)

Image for reference

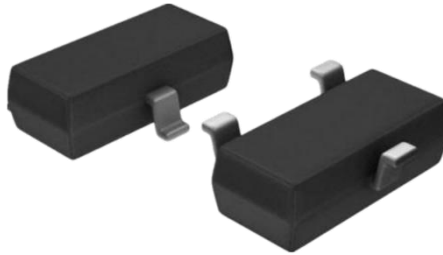

Marking: G1

SOT-23

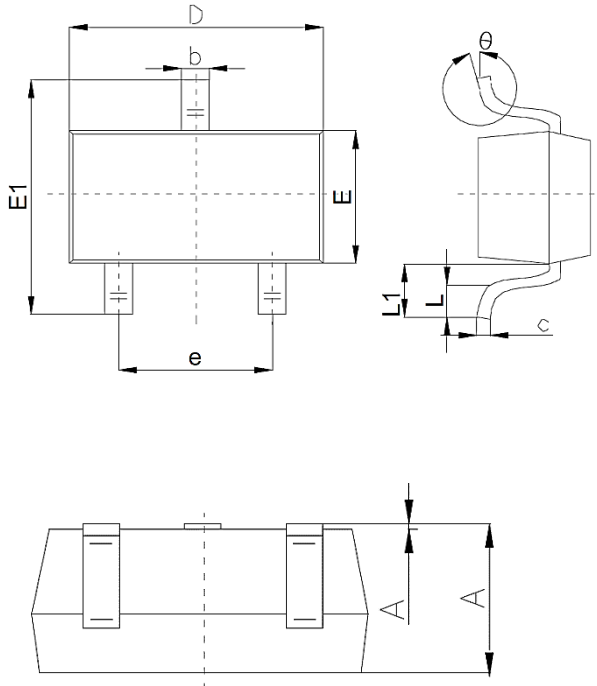

Symbol	Value (mm)		
	Min.	Typ.	Max.
A	0.9		1.4
A1			0.10
b	0.30		0.50
c	0.08		0.20
D	2.80	2.90	3.10
E	1.20		1.60
E1	2.25		2.80
e	1.80	1.90	2.00
L	0.10		0.50
L1	0.40		0.55
θ	0°		10°

Recommend Pad Layout

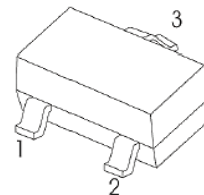
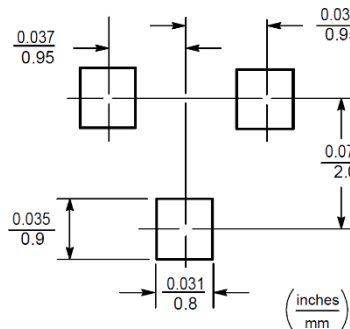

- 1.Base
- 2.Emmitter
- 3.Collector

SMD PLASTIC-ENCAPULATE TRANSISTORS SOT23 SERIES

MECHANICAL DATA

Case	Terminals	Polarity	Mounting Position	Weight per piece
JEDEC SOT-23 molded plastic body	Solder plated, Solderable per MIL-STD-750, Method 2026	Polarity symbol marking on case	Any	0.00019 Ounce, 0.00591 grams

MAX. RATINGS AT Ta=25 °C

Parameter	SYMBOLS	VALUE	UNITS
		LIMIT	
Collector-Base Voltage	V _{CBO}	180	Volts
Collector-Emitter Voltage	V _{CEO}	160	Volts
Emitter-Base Voltage	V _{EBO}	6	Volts
Collector Current	I _C	600	mA
Collector Power Dissipation	P _C	300	mW
Thermal Resistance Junction to Ambient	R _{QJA}	416	°C/W
Junction temperature	T _J	+150	°C
Storage temperature range	T _{STG}	-55 ~ +150	°C

SMD PLASTIC-ENCAPULATE TRANSISTORS SOT23 SERIES
ELECTRICAL CHARACTERISTICS AT Ta= 25 °C

Parameter	SYMBOLS	VALUE			UNIT	Condition
		Min.	Typ.	Max.		
Collector-base Breakdown Voltage	$V_{(BR)CBO}$	180			V	$I_C = 100\mu A, I_E = 0$
Collector-emitter Breakdown Voltage	$V_{(BR)CEO}^*$	160			V	$I_C = 1mA, I_B = 0$
Emitter-base Breakdown Voltage	$V_{(BR)EBO}$	6			V	$I_E = 10\mu A, I_C = 0$
Collector Cut-off Current	I_{CBO}			50	nA	$V_{CB} = 120V, I_E = 0$
Emitter Cut-off Current	I_{EBO}			50	nA	$V_{EB} = 4V, I_C = 0$
DC Current Gain	$h_{FE(1)}^*$	80				$V_{CE} = 5V, I_C = 1mA$
	$h_{FE(2)}^*$	100		300		$V_{CE} = 5V, I_C = 10mA$
	$h_{FE(3)}^*$	50				$V_{CE} = -5V, I_C = 50mA$
Collector-emitter Saturation Voltage	$V_{CE(sat)}^*$			0.15	V	$I_C = 10mA, I_B = 1mA$
				0.2	V	$I_C = 50mA, I_B = 5mA$
Base-emitter Saturation Voltage	$V_{BE(sat)}^*$			1	V	$I_C = 10mA, I_B = 1mA$
				1	V	$I_C = 50mA, I_B = 5mA$
Transition Frequency	f_T	100		300	MHz	$I_{CE} = 5V, I_C = 10mA, f = 30MHz$
Collector Output Capacitance	C_{ob}			6	pF	$V_{CB} = 10V, I_E = 0, f = 1MHz$

*Pulse test: pulse width $\leq 300\mu s$, duty cycles $\leq 2.0\%$.

CLASSIFICATION OF h_{FE}

Rank	L	H
Range	100 ~ 200	200 ~ 300

SMD PLASTIC-ENCAPULATE TRANSISTORS SOT23 SERIES
RELIABILITY

Number	Experiment Items	Experiment Method And Conditions	Reference Documents
1	Solder Resistance Test	Test 260°C± 5°C for 10 ± 2 sec. Immerse body into solder 1/16" ± 1/32"	MIL-STD-750D METHOD-2031.2
2	Solderability Test	230°C ±5°C for 5 sec.	MIL-STD-750D METHOD-2026.1 0
3	Pull Test	1 kg in axial lead direction for 10 sec.	MIL-STD-750D METHOD-2036.4
4	Bend Test	0.5Kg Weight Applied To Each Lead, Bending Arcs 90 °C ± 5 °C For 3 Times	MIL-STD-750D METHOD-2036.4
5	High Temperature Reverse Bias Test	TA=100°C for 1000 Hours at VR=80% Rated VR	MIL-STD-750D METHOD-1038.4
6	Forward Operation Life Test	TA=25°C Rated Average Rectified Current	MIL-STD-750D METHOD-1027.3
7	Intermittent Operation Life Test	On state: 5 min with rated IRMS Power Off state: 5 min with Cool Forced Air. On and off for 1000 cycles.	MIL-STD-750D METHOD-1036.3
8	Pressure Cooker Test	15 PSIG, TA=121°C, 4 hours	MIL-S-19500 APPENOIXC
9	Temperature Cycling Test	-55°C~+125°C; 30 Minutes For Dwelled Time 5 minutes for transferred time. Total: 10 cycles.	MIL-STD-750D METHOD-1051.7
10	Thermal Shock Test	0°C for 5 minutes., 100°C for 5minutes, Total: 10 cycles	MIL-STD-750D METHOD-1056.7
11	Forward Surge Test	8.3ms Single Sale Sine-wave One Surge.	MIL-STD-750D METHOD-4066.4
12	Humidity Test	TA=65°C, RH=98% for 1000 hours.	MIL-STD-750D METHOD-1021.3
13	High Temperature Storage life Test	150°C for 1000 Hours	MIL-STD-750D METHOD-1031.5

SMD PLASTIC-ENCAPULATE TRANSISTORS SOT23 SERIES

SUGGESTED REFLOW PROFILE (For Reference Only)

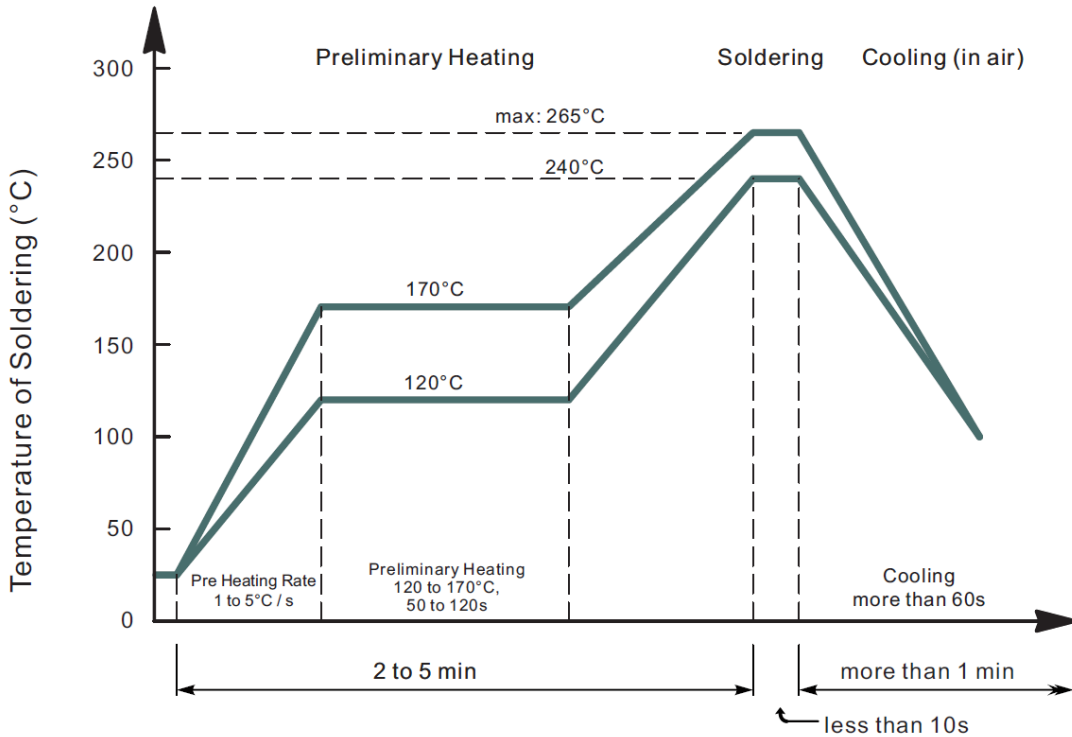

- Recommended peak temperature is over 245°C, If peak temperature is below 245 °C, you may adjust the following parameters; time length of peak temperature (longer), time length of soldering (longer), thickness of solder paste (thicker)
- Welding shall not exceed 2 times
- Remark: lead free solder paste (96.5 sn/3.0 Ag/0.5Cu)

SMD PLASTIC-ENCAPULATE TRANSISTORS SOT23 SERIES

RATINGS AND CHARACTERISTIC CURVES (For Reference Only)

Fig.1 Static characteristics

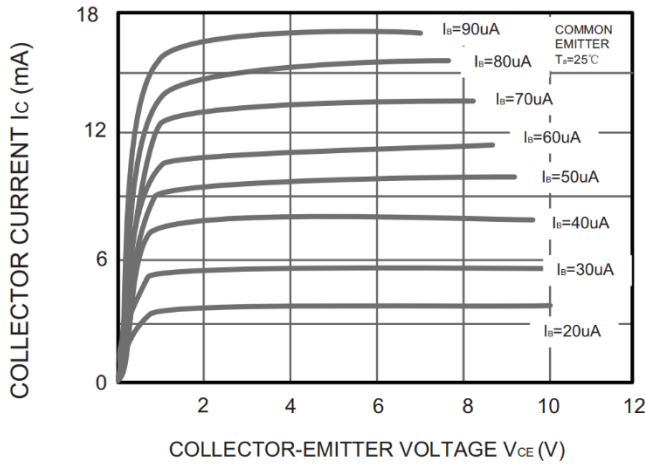

Fig.2 P_c — T_a

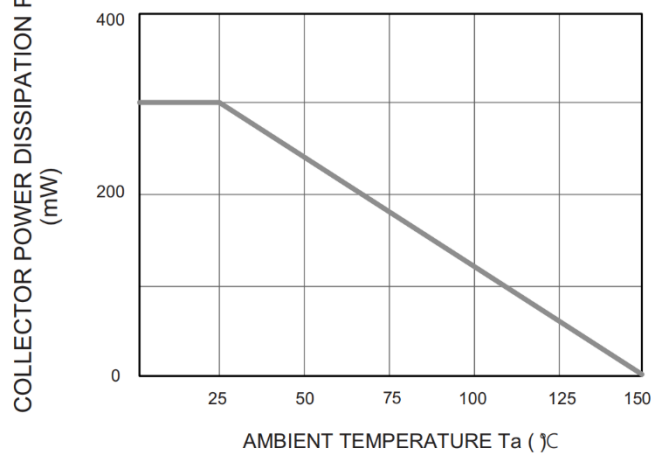

Fig.3 C_{ob} / C_{ib} — V_{CB} / V_{EB}

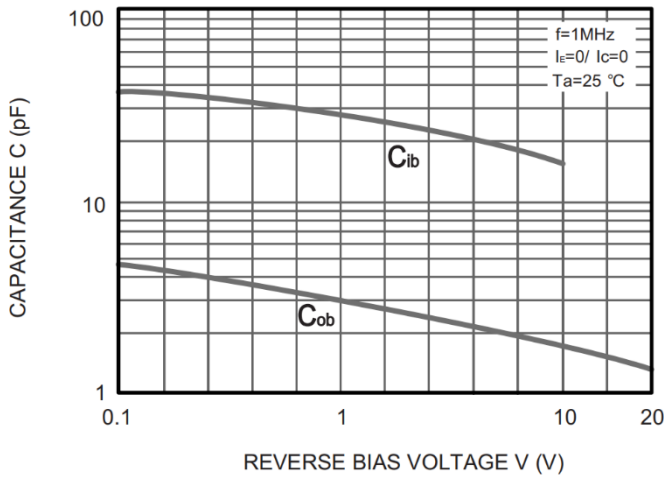
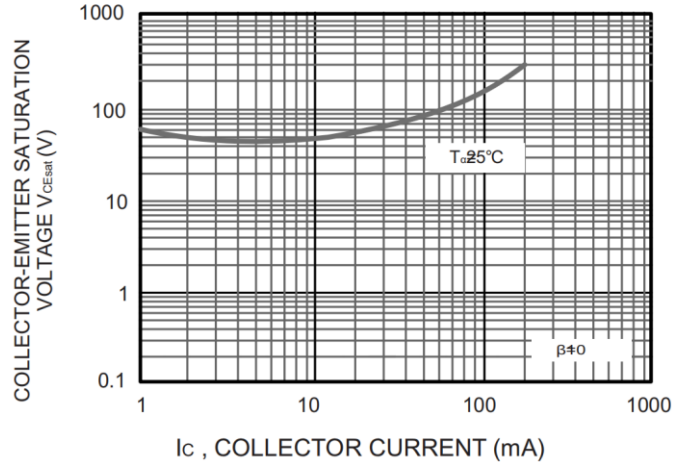

Fig.4 V_{CEsat} — I_c



SMD PLASTIC-ENCAPULATE TRANSISTORS SOT23 SERIES

RATINGS AND CHARACTERISTIC CURVES (For Reference Only)

Fig.5 $h_{FE} \rightarrow I_c$

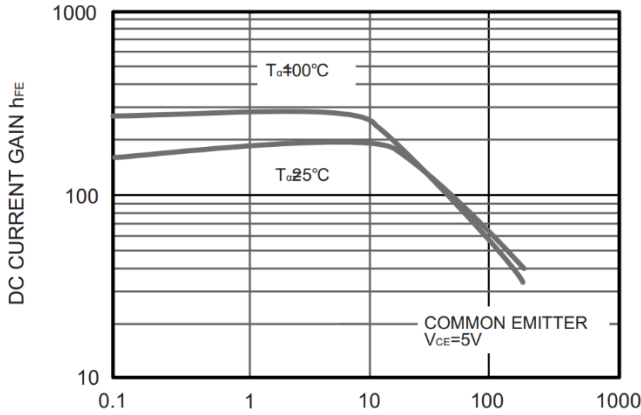

Fig.6 $V_{BEsat} \rightarrow I_c$

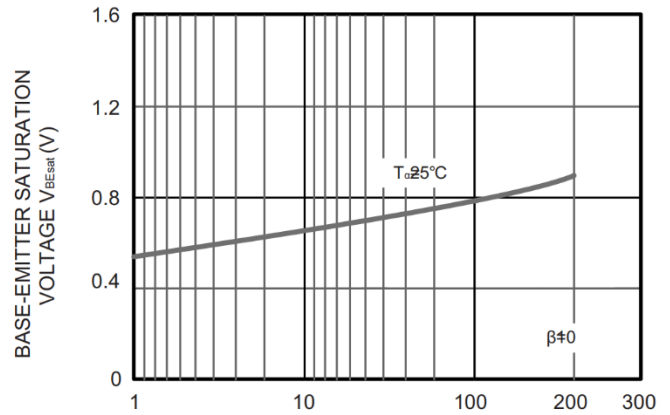

Fig.7 $I_c \rightarrow V_{BE}$

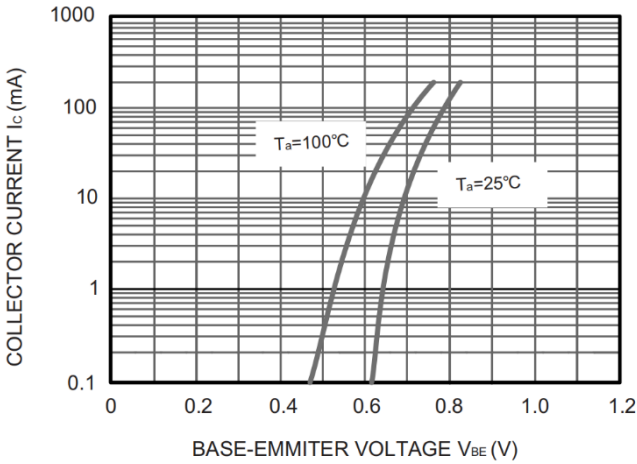
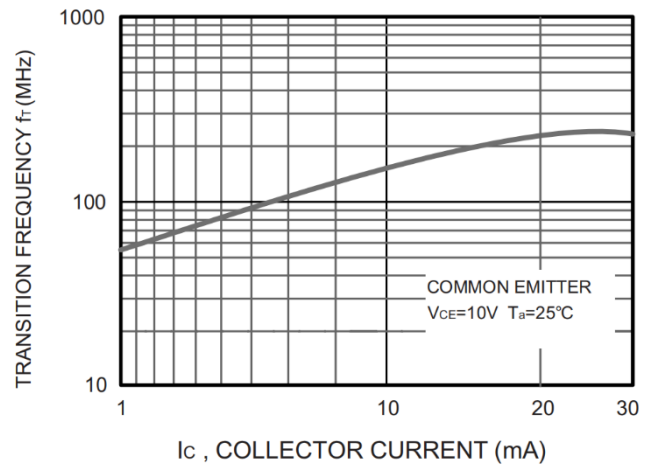
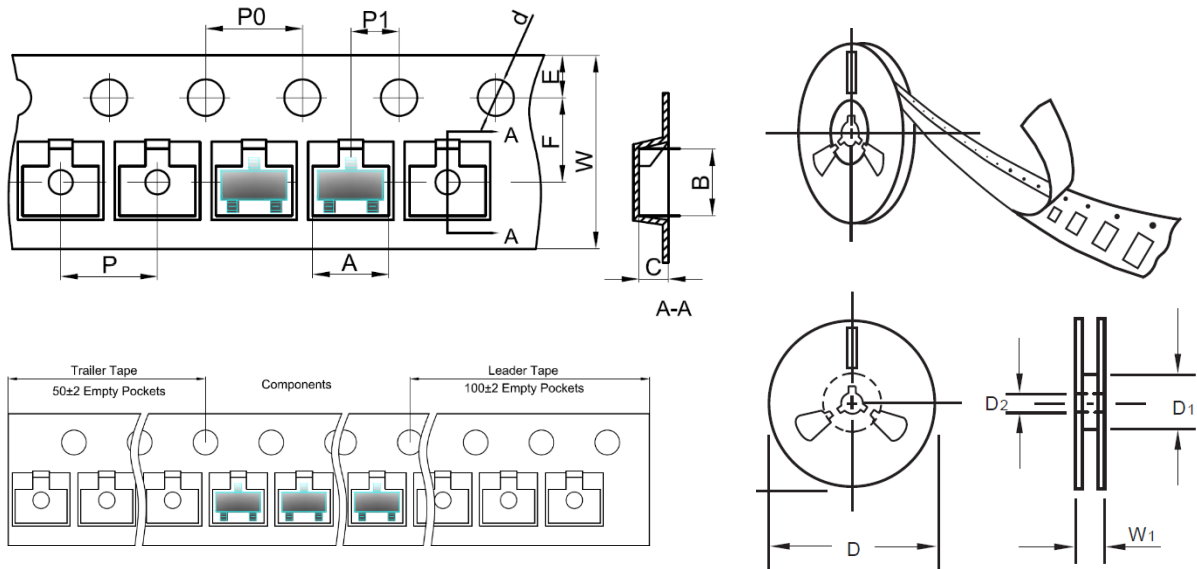

Fig.8 $f_T \rightarrow I_c$



SMD PLASTIC-ENCAPULATE TRANSISTORS SOT23 SERIES
TAPE/REEL (Unit: mm)

All Devices are packed in accordance with EIA standard RS-481-A and specifications.



Item	Symbol	Tolerance	SOT-23
Carrier width	A	0.1	3.15
Carrier Length	B	0.1	2.77
Carrier Depth	C	0.1	1.22
Sprocket hole	d	0.05	1.55
7"Reel outside diameter	D	2.0	178.00
7"Reel inner diameter	D1	Min.	54.4
Feed hole diameter	D2	0.5	13.00
Sprocket hole position	E	0.1	1.75
Punch hole position	F	0.1	3.50
Punch hole pitch	P	0.1	4.00
Sprocket hole pitch	P0	0.1	4.00
Embossment center	P1	0.1	2.00
Overall tape thickness	T	0.1	0.25
Tape width	W	0.3	8.00
Reel width	W1	1.0	19.50

SMD PLASTIC-ENCAPULATE TRANSISTORS SOT23 SERIES

PACKAGE

Case Code	SOT-23
Reel Size	7"
Reel Size	178 mm
MPQ/Reel	3000 pcs
Qty. /Box	6000 pcs
G.W/Box	1 LBS

DISCLAIMER

NextGen Component, Inc. reserves the right to make changes to the product(s) and or information contained herein without notice. No liability is assumed as a result of their use or application. No rights under any patent accompany the sale of any such product(s) or information