



SPECIFICATION SHEET

SPECIFICATION SHEET NO.	N0310-SMCRS3MC00S30A
DATE	Mar. 10, 2021
REVISION	A0
DESCRIPTION	SMD Fast Recovery Rectifier, SMC series, RS3MC Type, 2 Pads, Reverse Voltage 1000V Max. Forward Current 3.0A Max. Operating Temp. Range -55°C ~+150°C, Package in Tape/Reel, 3000pcs/Reel RoHS/RoHS III compliant
CUSTOMER	
CUSTOMER PART NUMBER	
CROSS REF. PART NUMBER	
ORIGINAL PART NUMBER	MDD RS3MC
PART CODE	SMCRS3MC00S30A

VENDOR APPROVE			
Issued/Checked/Approved			
DATE: March 10, 2021			

CUSTOMER APPROVE	
DATE:	

SMD FAST RECOVERY RECTIFER SMC SERIES



MAIN FEATURE

- The plastic package carries Underwriters Laboratory Flammability Classification 94V-0
- Low reverse leakage
- Open Junction chip
- High forward surge current capability
- High temperature soldering guaranteed: 250°C/ 10 seconds at terminals
- Glass passivated chip junction

APPLICATION

- For printed circuit board

RFQ

[Request For Quotation](#)

PART CODE GUIDE

SMC	RS3MC00	S	30A
1	2	3	4

- 1) **SMC**: SMD Fast Recovery Rectifier, 2 pads SMC series
- 2) **RS3MC00**: Type code for original part number RS3MC
- 3) **S**: Package code, Tape/reel, 3000pcs/reel.
- 4) **30A**: Specification code for Reverse Voltage 1000V Max. Forward Current 3.0A Max.

MORE ITEMS AVAILABLE

SMCRS3AC00S305	SMCRS3BC00S310	SMCRS3DC00S320	SMCRS3GC00S340	SMCRS3JC00S360
SMCRS3KC00S380	SMCRS3MC00S30A			
SMCRS5AC00S505	SMCRS5BC00S510	SMCRS5DC00S520	SMCRS5GC00S540	SMCRS5J00S560
SMCRS5K00S580	SMCRS5M00S50A			

SMD FAST RECOVERY RECTIFIER SMC SERIES

DIMENSION (Unit: Inch/mm)

Image for reference



Marking: RS3MC

SMC/DO-214AB

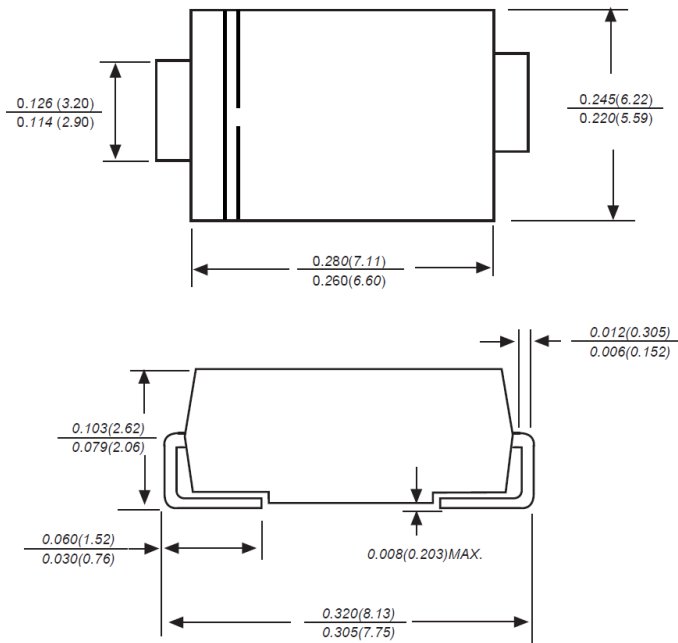

Recommend Pad Layout

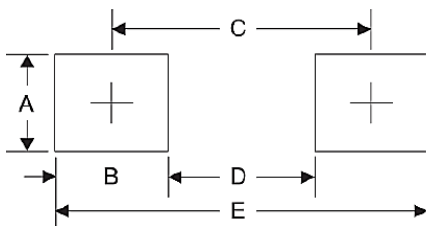

Symbol	Unit (inch)	Unit (mm)
A	0.170	4.30
B	0.160	4.10
C	0.311	7.90
D	0.150	3.80
E	0.472	12.0

SMD FAST RECOVERY RECTIFIER SMC SERIES
MECHANICAL DATA

Case	Terminals	Polarity	Mounting Position	Weight per piece
JEDEC SMC/DO-214AB molded plastic body	Solder plated, Solderable per MIL-STD-750, Method 2026	Polarity symbol marking on case	Any	0.0070 Ounce, 0.2180 grams

MAX. RATING & CHARACTERISTICS

Parameter	SYMBOLS	VALUE			UNITS
		Min.	Typical	Max.	
Repetitive peak reverse voltage	V _{RRM}			1000	Volts
RMS voltage	V _{RMS}			700	Volts
DC blocking voltage	V _{DC}			1000	Volts
Average forward output rectified current at TL= 90°C	I _{AV}			3.0	A
Peak forward surge current 8.3ms single half sine-wave superimposed on rated load (JEDEC Method)	I _{FSM}		100		A
Instantaneous forward voltage at 3.0A	V _F			1.30	Volts
DC reverse current at rated DC blocking voltage	I _R	TA=25°C		5.0	µA
		TA=125°C		100	µA
Reverse recovery Time (Note 2)	t _{rr}			500	ns
Junction capacitance (Note 3)	C _J		60		pF
Thermal resistance (Note 4)	R _{QJA}		50		°C/W
Operating junction temperature range	T _J	-55		+150	°C
Storage temperature range	T _{STG}	-55		+150	°C

Note

- Ratings at 25 C ambient temperature unless otherwise specified. Single phase half-wave 60Hz, resistive or inductive load, for capacitive load current derate by 20%.
- Reverse recovery condition IF=0.5A,IR=1.0A,Irr=0.25A
- Measured at 1.0MHz and applied reverse voltage of 4.0Voltage
- P.C.B. mounted with 0.2x0.2"(5.0x5.0mm) copper pad areas.

SMD FAST RECOVERY RECTIFIER SMC SERIES
RELIABILITY

Number	Experiment Items	Experiment Method And Conditions	Reference Documents
1	Solder Resistance Test	Test 260°C± 5°C for 10 ± 2 sec. Immerse body into solder 1/16" ± 1/32"	MIL-STD-750D METHOD-2031.2
2	Solderability Test	230°C ±5°C for 5 sec.	MIL-STD-750D METHOD-2026.1 0
3	Pull Test	1 kg in axial lead direction for 10 sec.	MIL-STD-750D METHOD-2036.4
4	Bend Test	0.5Kg Weight Applied To Each Lead, Bending Arcs 90 °C ± 5 °C For 3 Times	MIL-STD-750D METHOD-2036.4
5	High Temperature Reverse Bias Test	TA=100°C for 1000 Hours at VR=80% Rated VR	MIL-STD-750D METHOD-1038.4
6	Forward Operation Life Test	TA=25°C Rated Average Rectified Current	MIL-STD-750D METHOD-1027.3
7	Intermittent Operation Life Test	On state: 5 min with rated IRMS Power Off state: 5 min with Cool Forced Air. On and off for 1000 cycles.	MIL-STD-750D METHOD-1036.3
8	Pressure Cooker Test	15 PSIG, TA=121°C, 4 hours	MIL-S-19500 APPENOIXC
9	Temperature Cycling Test	-55°C~+125°C; 30 Minutes For Dwelled Time 5 minutes for transferred time. Total: 10 cycles.	MIL-STD-750D METHOD-1051.7
10	Thermal Shock Test	0°C for 5 minutes., 100°C for 5minutes, Total: 10 cycles	MIL-STD-750D METHOD-1056.7
11	Forward Surge Test	8.3ms Single Sale Sine-wave One Surge.	MIL-STD-750D METHOD-4066.4
12	Humidity Test	TA=65°C, RH=98% for 1000 hours.	MIL-STD-750D METHOD-1021.3
13	High Temperature Storage life Test	150°C for 1000 Hours	MIL-STD-750D METHOD-1031.5

SMD FAST RECOVERY RECTIFIER SMC SERIES

SUGGESTED REFLOW PROFILE (For Reference Only)

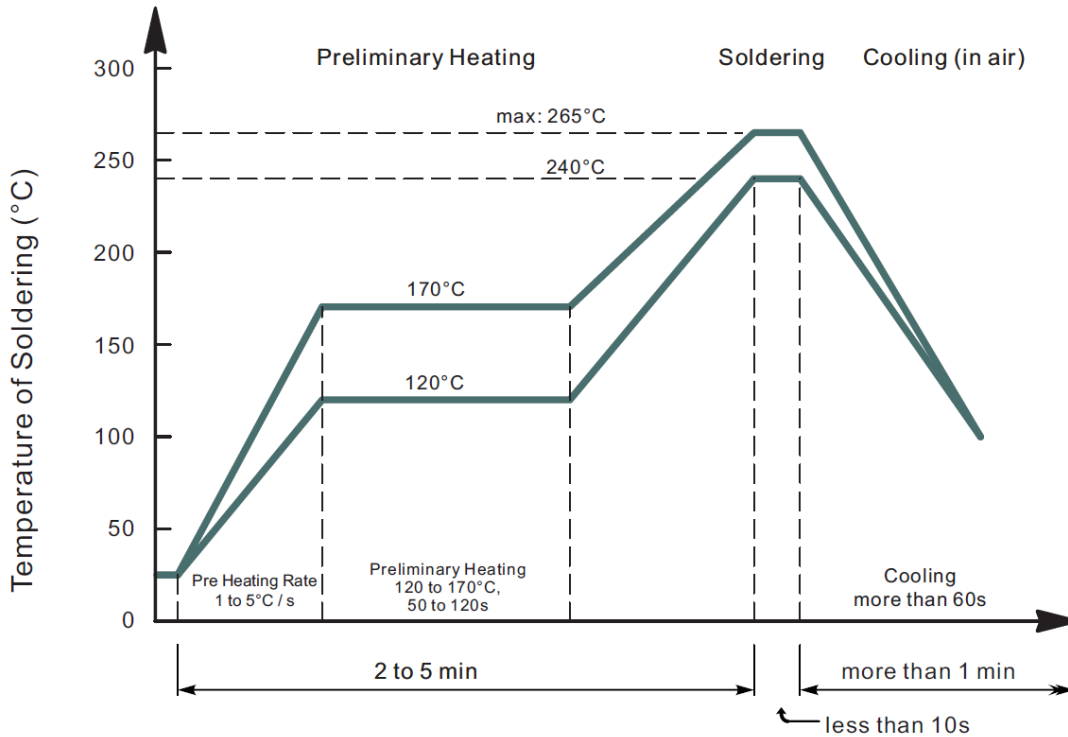

- Recommended peak temperature is over 245°C, If peak temperature is below 245 °C, you may adjust the following parameters; time length of peak temperature (longer), time length of soldering (longer), thickness of solder paste (thicker)
- Welding shall not exceed 2 times
- Remark: lead free solder paste (96.5 sn/3.0 Ag/0.5Cu)

SMD FAST RECOVERY RECTIFIER SMC SERIES

RATINGS AND CHARACTERISTIC CURVES (For Reference Only)

AVERAGE FORWARD RECTIFIED CURRENT
AMPERES

FIG. 1- FORWARD CURRENT DERATING CURVE

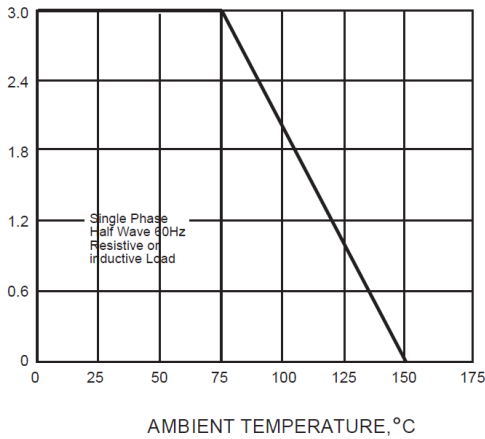

PEAK FORWARD SURGE CURRENT,
AMPERES

FIG. 2-MAXIMUM NON-REPETITIVE PEAK FORWARD SURGE CURRENT

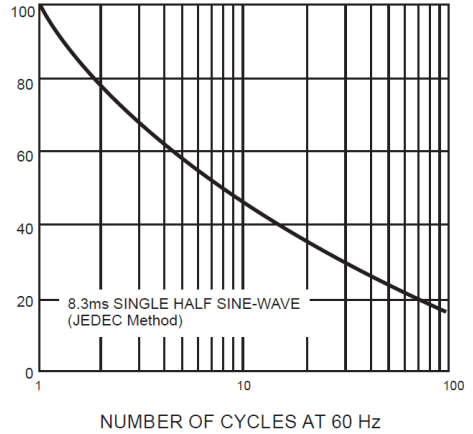

FIG. 3-TYPICAL INSTANTANEOUS FORWARD CHARACTERISTICS

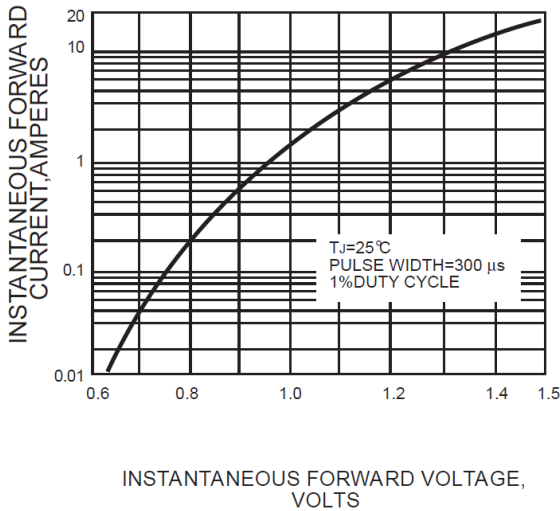

FIG. 4-TYPICAL REVERSE CHARACTERISTICS

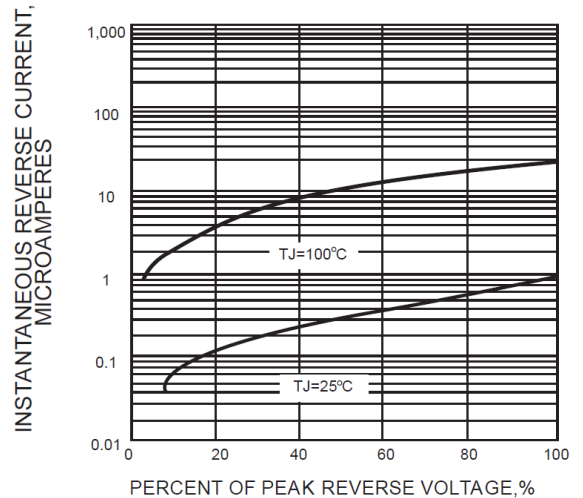

FIG. 5-TYPICAL JUNCTION CAPACITANCE

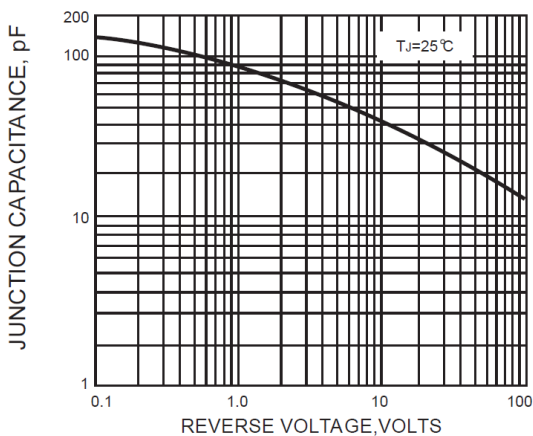
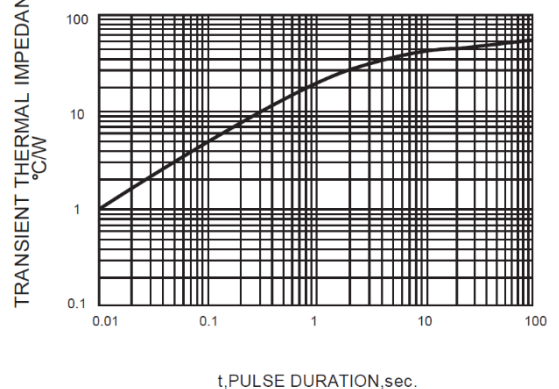

FIG. 6-TYPICAL TRANSIENT THERMAL IMPEDANCE



SMD FAST RECOVERY RECTIFIER SMC SERIES

TAPE/REEL (Unit: mm)

All Devices are packed in accordance with EIA standard RS-481-A and specifications.

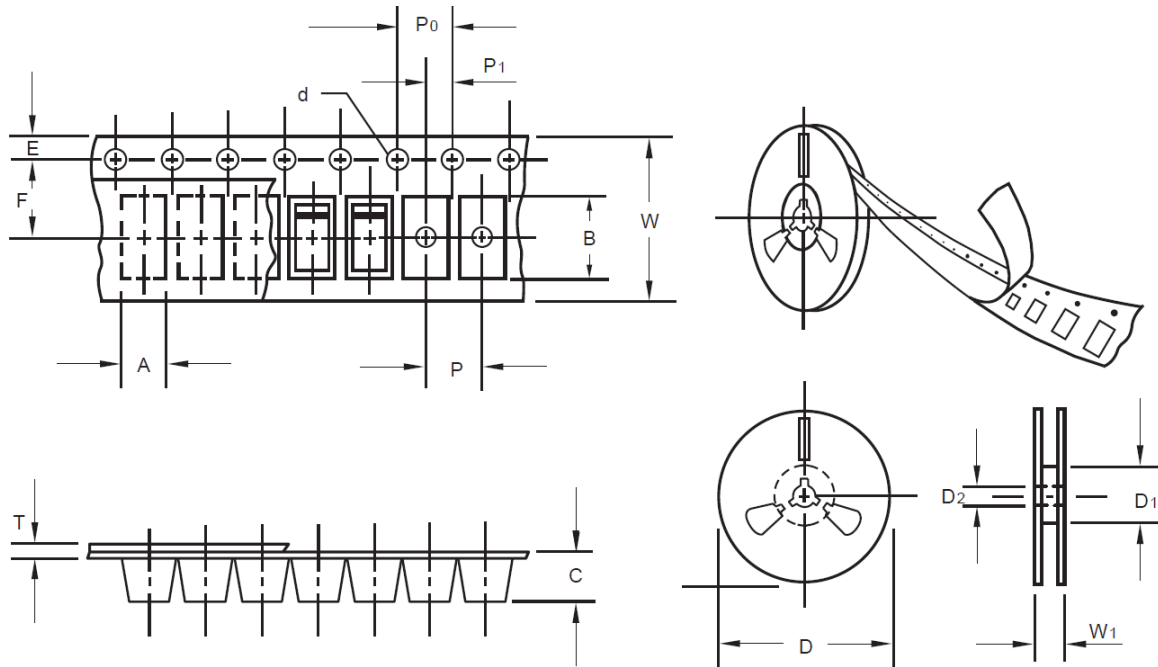

Item	Symbol	Tolerance	SMC/DO-214AB
Carrier width	A	0.1	6.15
Carrier Length	B	0.1	8.41
Carrier Depth	C	0.1	2.42
Sprocket hole	d	0.05	1.50
13" Reel outside diameter	D	2.0	330.00
13" Reel inner diameter	D1	Min.	50.00
7" Reel outside diameter	-	-	-
7" Reel inner diameter	-	-	-
Feed hole diameter	D2	0.5	13.00
Sprocket hole position	E	0.1	1.75
Punch hole position	F	0.1	7.50
Punch hole pitch	P	0.1	8.00
Sprocket hole pitch	P0	0.1	4.00
Embossment center	P1	0.1	2.00
Overall tape thickness	T	0.1	0.25
Tape width	W	0.3	16.00
Reel width	W1	1.0	16.50

SMD FAST RECOVERY RECTIFIER SMC SERIES

PACKAGE

Case Code	Reel Size	MPQ (pcs)	Component Spacing (mm)	Qty. Per Box (pcs)	Inner Box L*W*H (mm)	Reel Size (mm)	Carton size L*W*H (mm)	Qty. Per Carton (pcs)	G. W (kg)
SMC	13"	3,000		6,000	190*190*41	330	400*400*250	42,000	14.0

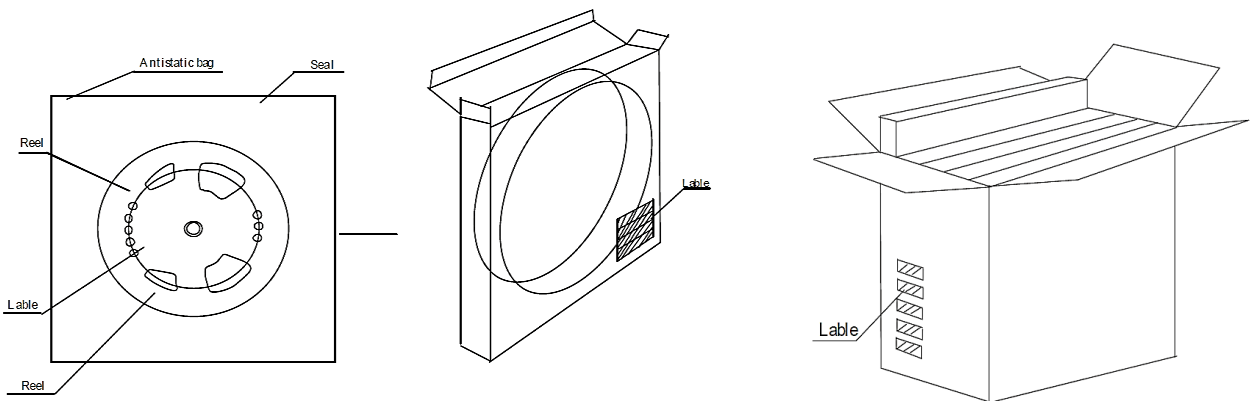

DISCLAIMER

NextGen Component, Inc. reserves the right to make changes to the product(s) and or information contained herein without notice. No liability is assumed as a result of their use or application. No rights under any patent accompany the sale of any such product(s) or information